



Curb Roller CM4000

Changing The Way Contractors Around The World Shape Concrete

AWARD. WINNING. INNOVATION.

The Curb Roller CM4000 by Curb Roller Manufacturing is an award winning innovation that continues to change the way contractors around the world shape concrete. The CM4000 is a single operator machine with an ergonomic design, helping to take most of the back-breaking labor out of shaping curb and gutter. Accomplish more with less labor and produce a uniform, high quality product each time!



LESS TIME

Increase production times with the Curb Roller CM4000. This machine allows you to shape an array of curbs, gutters, and more **at least 2X faster** than if you were to shape it by hand.



MORE JOBS

The CM4000 has the ability to easily switch out any of our over 20 drum profiles, as well as custom drums. Pair that with the decreased time shaping takes and it gives you the chance to fulfill more jobs.



MORE MONEY

More jobs + less time = more money. Thanks to the job increase potential, versatility, and the ability to maintain a consistent, higher quality shape, most companies will see an increase to their bottom line.



ONE MACHINE. MULTIPLE POSSIBILITIES.

Thanks to the CM4000's innovative design, it can be used on jobs of all sizes and types including patch and repair. It is built to stand up to the rigor of every day concrete work, and has an intuitive design to help get the job done.

With a powerful hydraulic drivetrain, a crew can utilize workers who don't have as much experience while still maintaining high quality results. The drums can easily be switched out, which means you don't have to be limited to one shaping style. Because of this, crews will see an average increase of 50% in their speed and production over the more traditional methods.

The CM4000 also gives contractors large and small the ability to do a broader scope of work, without having to invest in large, expensive equipment. This machine easily fits in the bed of a pickup, meaning you can take it anywhere the job calls for. Just hook it up to your hydraulic power source (i.e. skid loader, mini excavator, tractor, etc.) and you'll be ready to roll. Whether you run a large company with several crews, or a small three-man outfit, the CM4000 can directly improve your bottom line!



Some of the available accessories for the CM4000 are: Hydra-Pack, Monolithic Kit, Sidewalk Kit, Custom Drums, Matching Curb Tools, and the Hose Extension Kit.



Curb Roller Manufacturing currently offers over 25 stocked drum profiles with the added ability to create a custom drum for special projects. The CM4000 has an adjustable frame that will accommodate most widths of curb and gutter. Let us build a drum for your specific needs!

STOCK DRUMS

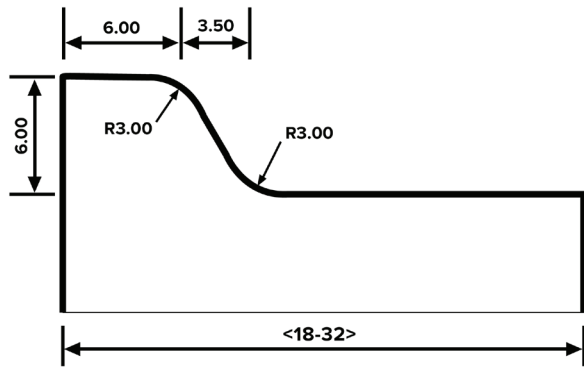

#1 Drum

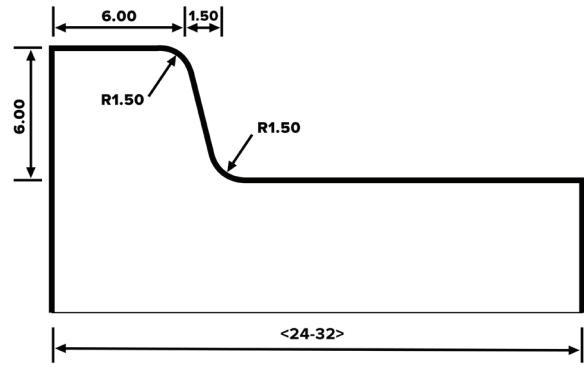

#2 Drum

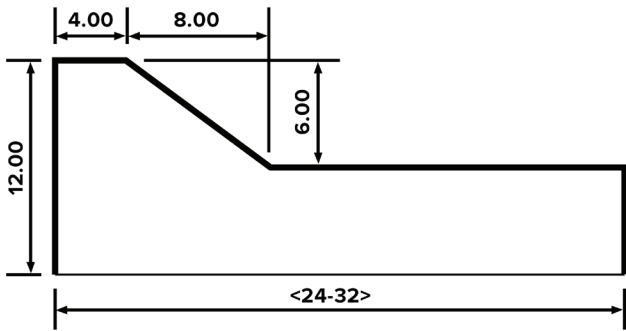

#3 Drum

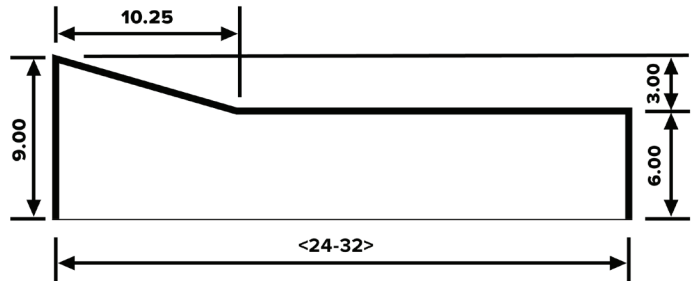

#4 Drum

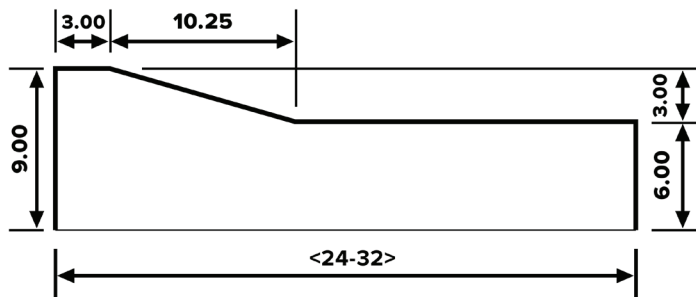

#5 Drum

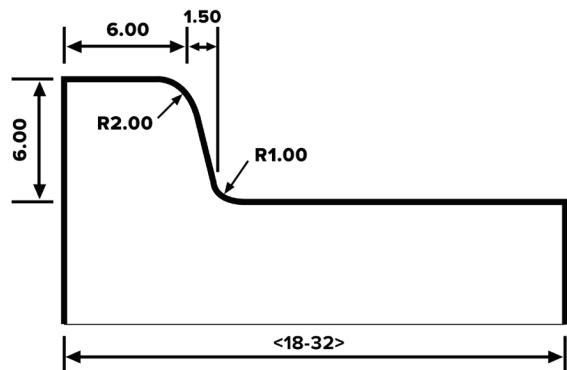

#6 Drum

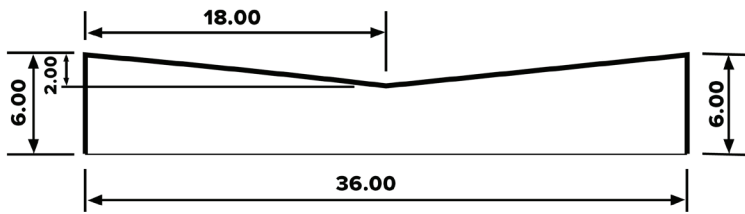

#7 Drum

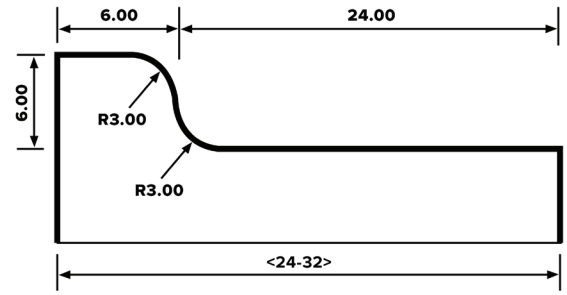

#8 Drum

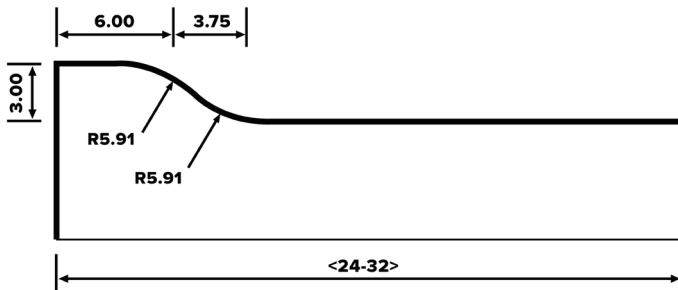

#9 Drum

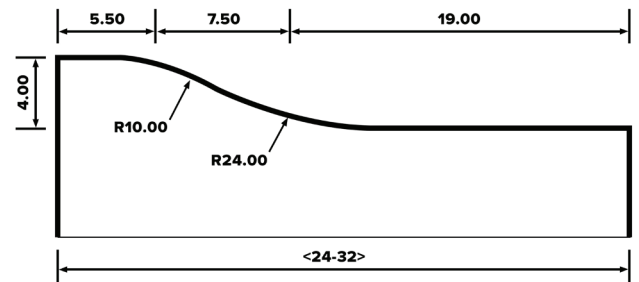

#10 Drum

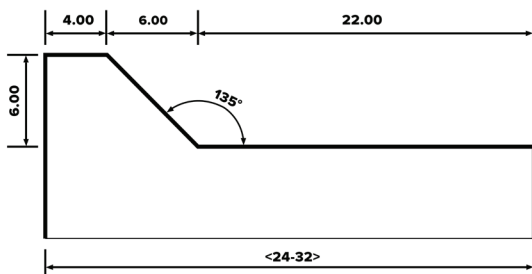

#11 Drum

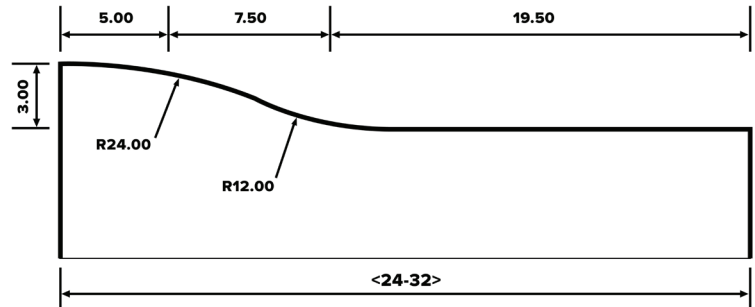

#12 Drum

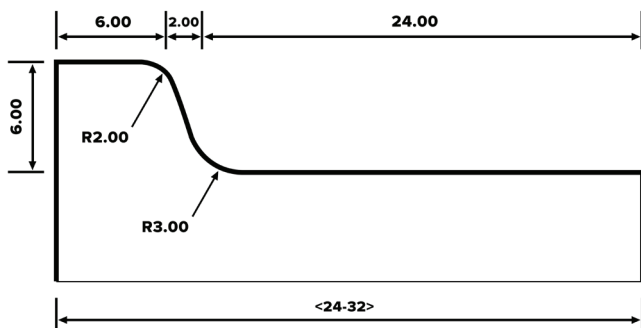

#13 Drum

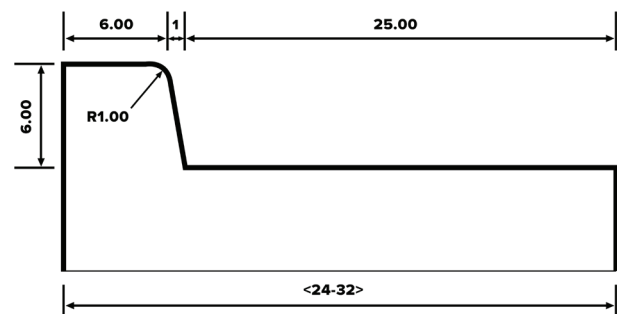

#14 Drum

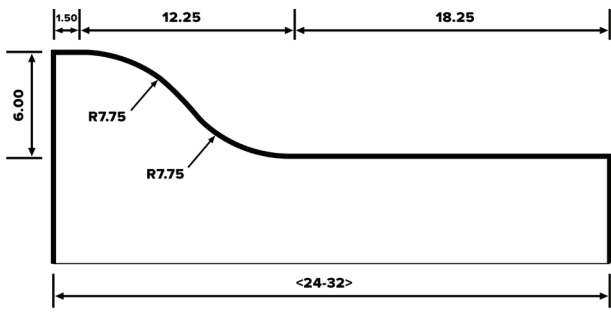

#15 Drum

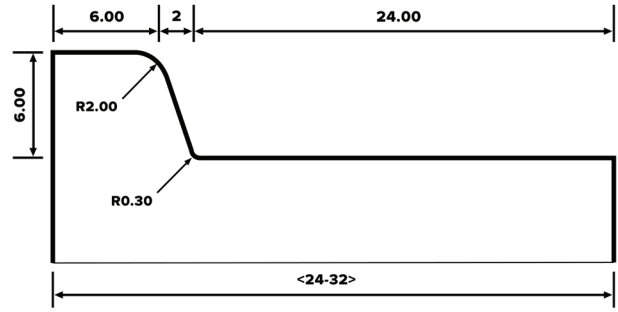

#16 Drum

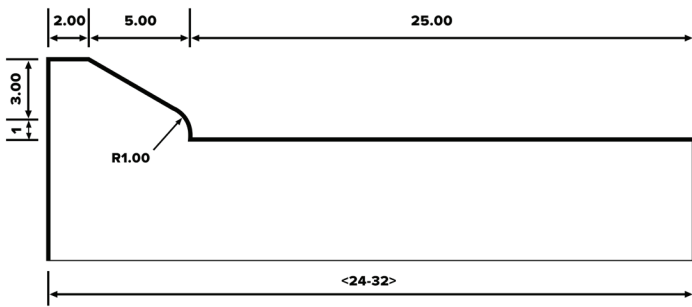

#17 Drum

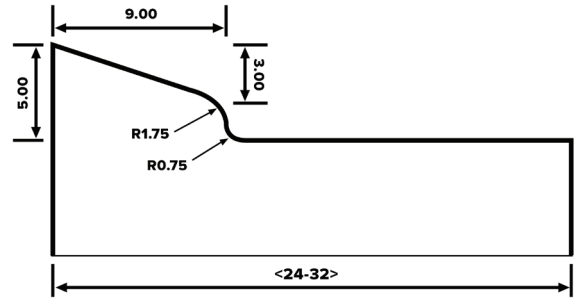

#18 Drum

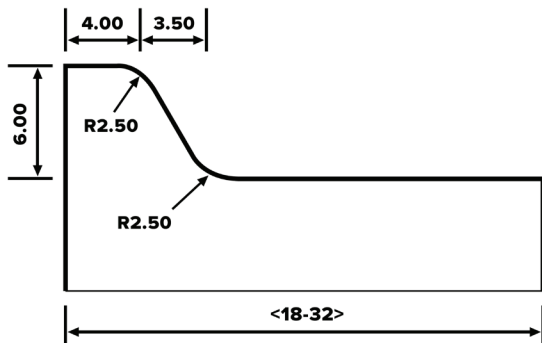

#19 Drum

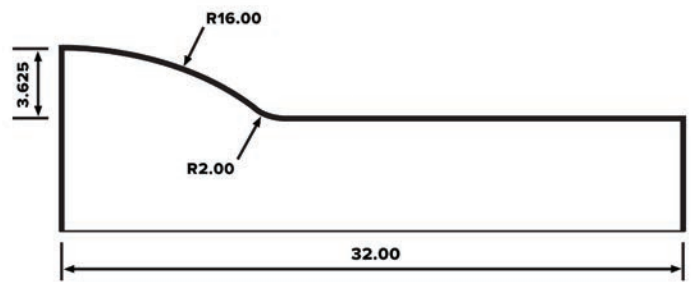

#20 Drum

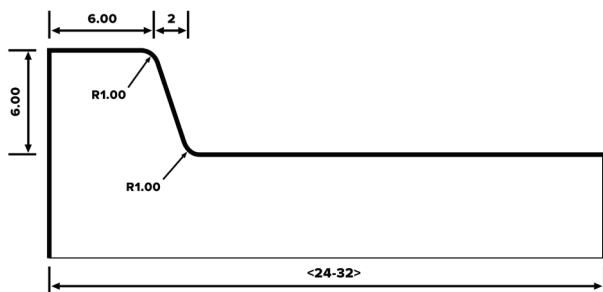

#21 Drum

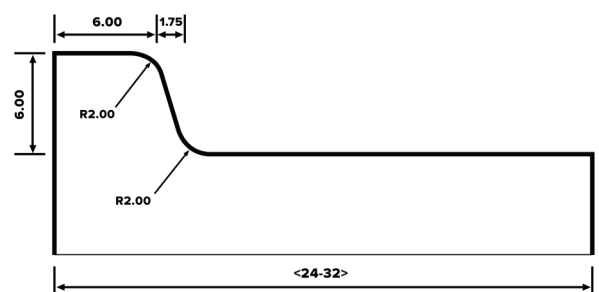

#22 Drum

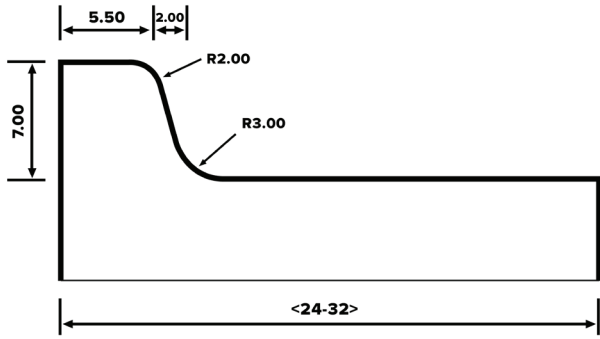

#23 Drum

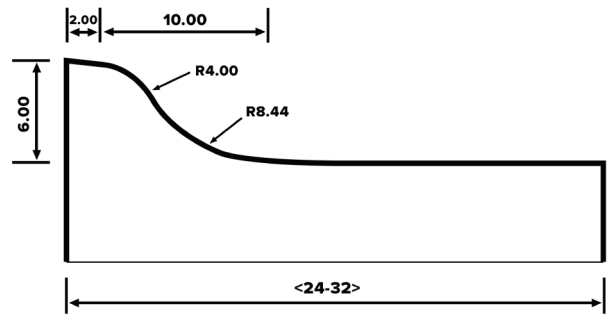

#24 Drum

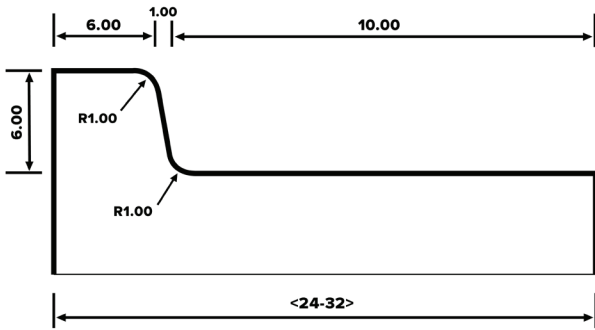

#25 Drum

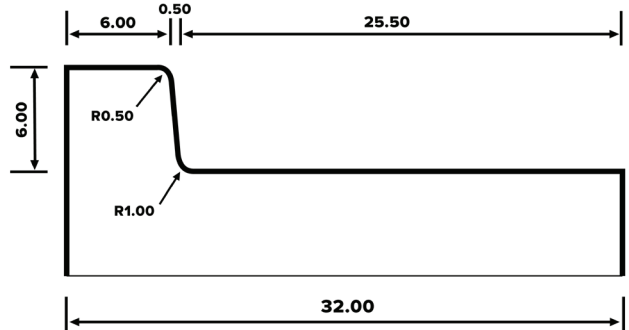

#26 Drum

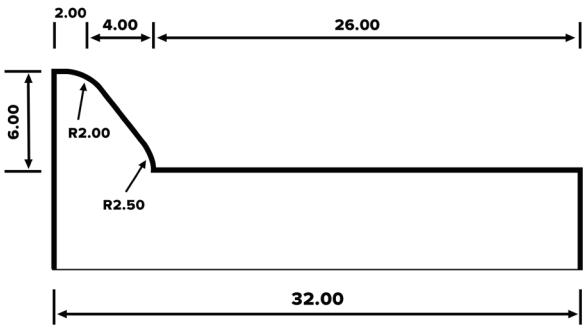

#27 Drum

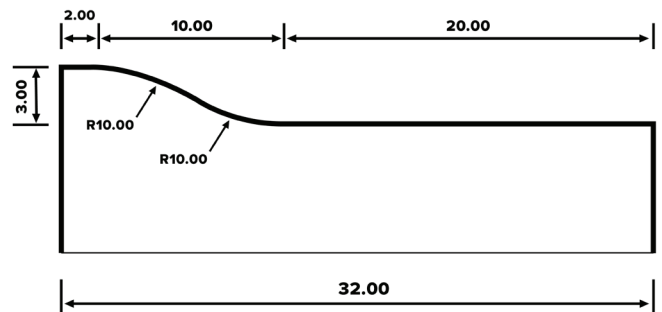

#28 Drum

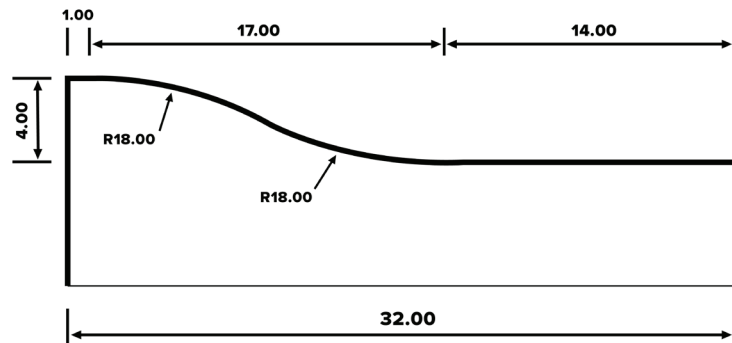

#29 Drum

CUSTOM DRUMS. BUILT TO SPEC.

The sooner concrete is shaped the better your pour will go. At Curb Roller Mfg. we are able to meet the specific needs of concrete contractors by building custom profiles based on your specifications. Tell us what you need and we'll see if it spins!

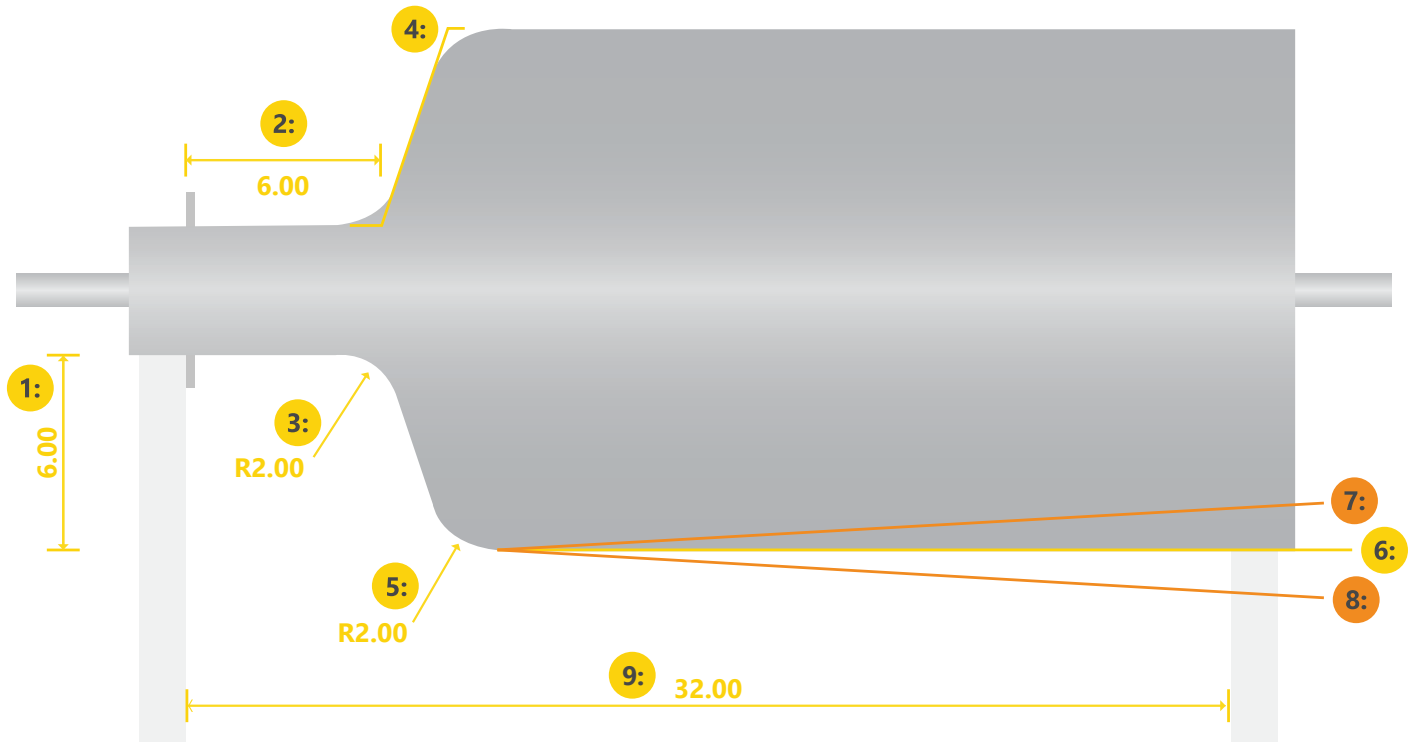

1. Curb Height

4. Batter/Layback

7. Catch/Inflow

2. Curb Head

5. Bottom Radius

8. Spill/Outflow

3. Top Radius

6. Gutter/Pan Length

9. Overall Concrete



Have a reference file or image? You can add it to the form on our website's Custom Drum page, or email it to us at info@curbroller.com.







CHOOSE YOUR PERFECT SET UP.

The Curb Roller CM4000 has an adjustable guide ring which allows the user to set the curb depth to a width of 7 inches. The handle has a variable speed and directional valve which give the operator ultimate control of the machine, and the handle position is also adjustable providing a more comfortable offset.

Two kits are available for the Curb Roller CM4000, allowing it to be even more versatile than ever. Our Monolithic Kit has a float pan assembly which allows crews to easily shape monolithic curb, storage unit lips and other depressions, and can be used on both old and new models. The CM4000 can also be fitted with our Sidewalk Kit which allows users to screed up to 6 feet wide.

For a full list of kits and accessories, call or visit our website.





CURB ROLLER CM4000



MORE THAN JUST CURB ROLLERS.

Curb Roller Manufacturing also produces the innovative Batt Screed, Hydra-Screed, and Hydra-Pack systems. Our Batt Screed utilizes a rechargeable 60-volt lithium ion battery for impressive power and run time, and eliminates exhaust fumes, cords, and hoses. The Hydra-Screed is powered by hydraulics and is operated manually, giving it the flexibility to tackle the toughest jobs with ease, while our Hydra-Pack delivers an impressive two-way directional flow that is perfect for job sites where other hydraulic power sources won't fit.

Cut your work time in half with our top of the line concrete shaping products today!



Scan the QR code for videos!



www.curbroller.com



785-467-3132



info@curbroller.com